

*Computer Science and Systems Analysis*  
*Computer Science and Systems Analysis*  
*Technical Reports*

---

*Miami University*

*Year 1992*

---

Design and Implementation of a  
Hypertext-based Information Retrieval  
System

Yuan Lee

Miami University, [commons-admin@lib.muohio.edu](mailto:commons-admin@lib.muohio.edu)



**MIAMI UNIVERSITY**  
**DEPARTMENT OF COMPUTER SCIENCE**  
**& SYSTEMS ANALYSIS**

**TECHNICAL REPORT: MU-SEAS-CSA-1992-011**

**Design and Implementation of a Hypertext-based  
Information Retrieval System**  
**Yuan Ming Lee**



**School of Engineering & Applied Science | Oxford, Ohio 45056 | 513-529-5928**

**Design and Implementation of a  
Hypertext-based Information Retrieval System**

**by**

**Yuan Ming Lee  
Systems Analysis Department  
Miami University  
Oxford, Ohio 45056**

**Working Paper #92-011**

**08/92**

SYSTEMS ANALYSIS DEPARTMENT  
MASTER'S PROJECT FINAL REPORT

Presented in Partial Fulfillment of the Requirements  
for the Degree of  
Master of Systems Analysis  
in the  
Graduate School of Miami University

TITLE: Design and Implementation of a Hypertext-based  
Information Retrieval System

PRESENTED BY: Yuan Ming Lee

DATE: August 13, 1992

COMMITTEE MEMBERS:

Fazli Can, Advisor

James D. Kiper

Alton Sanders

Fazli Can  
James D. Kiper  
Alton Sanders

**Design and Implementation  
of  
a Hypertext-based Information Retrieval System**

**Graduate Research**

**by**

**Yuan Ming Lee**

In Partial Fulfillment  
of the Requirements for the Degree  
Master in Systems Analysis

Miami University  
August, 1992

### **Abstract**

Information Retrieval (IR), which is also known as text or document retrieval, is the process of locating and retrieving documents that are relevant to the user queries. In hypertext environments, document databases are organized as a network of nodes which are interconnected by various types of links. This study introduces a hypertext-based text retrieval system, HypIR. In HypIR, the semantic relationships among documents are obtained using a clustering algorithm. A new approach providing the advantages of system maps and history list is introduced to prevent the user from being lost in the IR hyperspace. The paper presents the underlying concepts and implementation details. HypIR is based on the object-oriented paradigm of HyperCard.

## Approvals

Student: \_\_\_\_\_ Date:

Advisor: \_\_\_\_\_ Date:

Member: \_\_\_\_\_ Date:

Member: \_\_\_\_\_ Date:

## TABLE OF CONTENTS

	Page
ABSTRACT.....	ii
LIST OF TABLES.....	v
LIST OF FIGURES.....	vi
1. INTRODUCTION.....	1
2. DOCUMENT REPRESENTATION AND QUERY-DOCUMENT MATCHING.....	3
2.1. Generation of Document Representation.....	3
2.2. Query-Document Matching.....	4
3. SEARCH STRATEGIES.....	5
3.1. Full Search.....	5
3.2. Cluster-based Search.....	5
3.3. Clustering Algorithm.....	6
3.4. Implementation of Cluster-based Search.....	6
4. SYSTEM DATABASE AND FILES.....	7
4.1. System Database.....	7
4.2. System Files.....	7
5. USING HYPERTEXT FOR IR AND HYP-IR.....	9
5.1. Links and Nodes.....	9
5.2. Hypertext Browsing.....	10
5.3. HyperCard's Object-Oriented Philosophy.....	11
5.4. HypIR System Design and Implementation.....	12
6. CONCLUSION.....	17
7. REFERENCES.....	18
8. APPENDIX.....	20
I. Programming Details for HypIR.....	20
II. Summary of Programs and Files Used in HypIR.....	30
III. The Maintenance of HypIR.....	31



**LIST OF TABLES**

TABLE	Page
I. Characteristics of the TODS/TOIS Database.....	7

## LIST OF FIGURES

Figure		Page
1.	An example hypertext structure. ....	1
2.A	Example D matrix. ....	8
2.B	IID and IC file structures and templates. ....	9
3.	Hierarchical and network hypertext models ....	9
4.	The hierarchy of objects in HyperCard. ....	11
5.	HypIR system design. ....	13
6.	Main menu in HypIR. ....	14
7.	An example of document list in HypIR. ....	14
8.	Document card in HypIR. ....	15
9.	Query processing card in HypIR. ....	15
10.	Query modification dialog box. ....	16
11.	Term weight dialog box. ....	16
12.	Index windows. ....	16
13.	An example of Set Project Type... dialog box. ....	21
14.	Update card in HypIR. ....	31

# 1. INTRODUCTION

Information Retrieval (IR) is the process of locating and retrieving documents that are relevant to the user queries [SALT89]. In general, IR is accomplished using document representatives or surrogates. Whatever the representation of the documents, the major problem in IR is the query formulation. This is why several retrieval techniques are available in the IR literature [BELK87]. Among these techniques, the hypertext approach, which allows the user to navigate and inspect the database documents according to his own wishes, is the most intuitive one [NIEL90].

In hypertext environments, databases are organized as a network of nodes which are interconnected by various links. Through the links, the user can navigate or browse the documents in a non-sequential manner. This network browsing process is totally controlled by the user .

In a hypertext-based IR system, documents have multiple entries and numerous connections as shown in Figure 1.

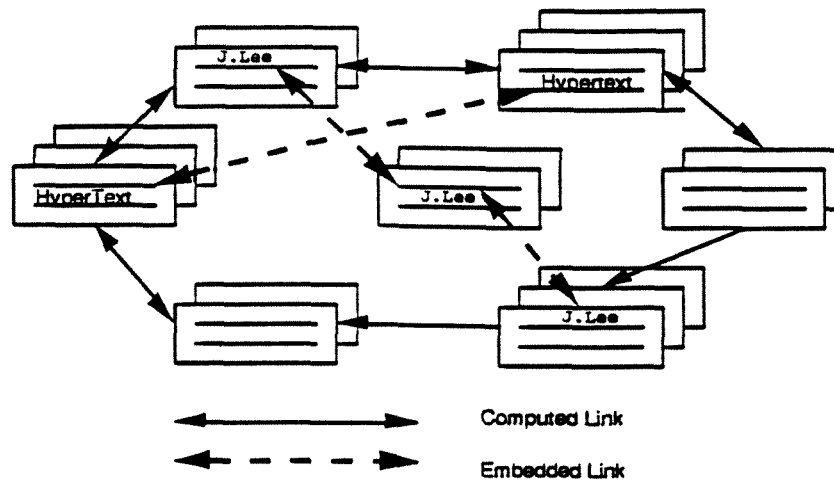

Figure 1. An example hypertext structure.

As shown in Figure 1, computed links are constructed whenever the user submits a query. On the other hand, embedded links may be provided by system functions. In such a system, the browsing of hypertext is triggered by some "optimal" starting nodes, which are the documents with high similarity to the user query. The user may then navigate among documents following the original query or, alternatively, the user may utilize system functions to find documents containing the same keywords or documents written by the same author, etc. Consequently, the user can become more and more familiar with the system and his information need. Thus, a query which is more accurate than the initial query can be formulated and more relevant documents can be found.

The recent IR literature contains various examples of hypertext-based IR systems sometimes with multimedia support. For example, American Memory is a multimedia integrated system which provides electronic images of selected collections of the Library of Congress. The system provides archival material related to American culture and history on CD-ROM discs and laser videodiscs. The multimedia database covers motion pictures, photographs, cartoons, speeches, songs and text [LIBC91].

The News Retrieval Tool (NRT), built at University of Glasgow in Scotland, is based on a probabilistic retrieval model. This system covers a collection of articles from Financial Times, and is designed to test retrieval improvement for users of the existing profile retrieval services [HARM92].

CANSEARCH, which is an application of artificial intelligence techniques, provides intelligent access to on-line information. It is designed to enable doctors to retrieve cancer-therapy-related documents from the MEDLINE database. To use CANSEARCH, the user must have sophisticated medical knowledge, but little IR experience [GAUC92].

I<sup>3</sup>R (Intelligent Interface for Information Retrieval) is a knowledge base system which allows the user to find information using various means. To retrieve documents, both natural language query and Boolean query formulation can be used [CROF87, THOM89].

HYPERLINE, which has been developed by the Information Retrieval Service of European Space Agency, is based on a two-level conceptual architecture for the construction of a hypertext environment for interacting with large textual databases. In HYPERLINE, the collection of documents of interest is placed in the first level and the semantically related concepts are placed in the second level. Meanwhile, various functions such as semantic association, navigation, sequential reading, backtracking and history list are also provided [AGOS92].

Another example of hypertext-based IR system with hierarchical cluster browsing capability is implemented by Crouch and his co-workers. This system allows the user to browse the nodes within a single link clustering structure. When using this system, the user is not expected to access best-matching documents directly. Instead, the user can utilize the similarity values and single link structure to decide which clusters should be visited [CROU89].

An application of the hypertext and IR techniques on a medical handbook is defined by Frisse. In his system the links are defined by already existing hierarchical relationships of different sections of the handbook [FRIS88].

In this paper, we introduce a hypertext-based text retrieval system, HypIR. As in any other information system, efficiency and effectiveness are the main concerns. Efficiency

and effectiveness are, respectively, associated with the time and space required for searching and with the quality of retrieval. The implementation principles of HypIR are proven to be both effective and efficient [CAN90, CAN92a, CAN92b]. In HypIR, since the documents are independently created, the semantic relationships among documents are obtained using the Cover Coefficient-based Clustering Methodology (C<sup>3</sup>M). This algorithm generates statistically valid clusters (i.e. groups of documents that are strongly associated with each other) which are appropriate for IR [CAN90]. The selection of documents from the generated clusters is performed using inverted index search techniques. HypIR is implemented using HyperCard and THINK Pascal. The system has a dynamic nature and documents can easily be added and deleted.

The paper is organized as follows. Section 2 briefly introduces the concepts of document representation and query-document matching process. In hypertext browsing, Full Search (FS) and Cluster-based Search (CS) provide the so-called "optimal" browsing starting points. Section 3 covers the principles of FS and the details of CS. Section 4 and 5, respectively, provide the data and file structures, and the design principles used for the implementation of HypIR. In Section 6, a conclusion is provided. Finally, three appendices are included to aid future graduate students who will work on projects related to the HypIR system.

## **2. DOCUMENT REPRESENTATION AND QUERY-DOCUMENT MATCHING**

In the design and implementation of IR systems, some decisions should be made for the techniques of document representation, query-document matching and searching strategies. Thus, before getting into the details of HypIR, we would like to introduce the techniques that are adopted in HypIR and the reasons that support the selection of these techniques. This section considers document representation and query-document matching, and the next section considers the search strategies.

### **2.1 Generation of Document Representatives**

In IR, two common approaches for document representative generation are document signatures and the vector space model [SALT89]. The document signature approach uses a bit map array for each document whose entries are set by a hash function using the words of documents as its input [FALO85]. In the vector space model, the approach used in this study, each document is represented by a document vector describing the words, or terms, which appear in the associated document. This model is simple and appropriate for hypertext environments [SALT89, CROU89].

According to the vector space model, a document database simply becomes a document,  $D$ , matrix. For a database of  $m$  documents defined by  $n$  terms, an entry in the

D matrix in row  $i$  (document  $i$ ) at column  $j$  (term  $j$ ),  $d_{ij}$  ( $1 \leq i \leq m$ ,  $1 \leq j \leq n$ ), represents the weight, or frequency of term  $j$  in document  $i$  (i.e. the number of occurrences of term  $j$  in document  $i$ ).

When constructing the D matrix, a stemming algorithm should be adopted to reduce the size of the D matrix. For the documents or queries written in natural English, it is known that terms with a common stem will usually have similar meanings such as the following.

attract, attracted, attraction and attractive

Thus, if the IR system can recognize the various suffixes (-ed, -ion, -ive, etc.) and remove them from the stem, "attract," the complexity of the system and the storage requirement of the database can both be reduced. In HypIR, the stemming program is coded using Porter's algorithm [PORT80]. Porter's algorithm is simple, compared to other stemming algorithms, but effective [HARM91].

## 2.2 Query - Document Matching

No single search strategy can satisfy all users' queries. Therefore, it is desirable that an IR system should have more than one search strategy. Two common search techniques are Full Search (FS) and Cluster-based Search (CS). FS has the best performance in terms of retrieval effectiveness and CS facilitates document browsing. For both, a query matching (similarity) function, also described as a search machine, determines which documents or clusters potentially relevant (i.e. match the query) and should be returned to the user.

Several matching functions based on term weighting components of document and query terms have been introduced in the IR literature. Term weighting consists of three components, the term frequency component (TFC), the collection frequency component (CFC), and the normalization component (NC). Both the weights of terms in a document and a query (denoted by  $w_{dj}$  and  $w_{qj}$ ,  $1 \leq j \leq n$ ) can be derived by multiplying the term weights of these three components. After obtaining the term weights, the similarity between a document  $d$  and a query  $q$  can be defined as follows [SALT89].

$$\text{similarity}(d, q) = \sum_{k=1}^n w_{dk} \cdot w_{qk}$$

where  $n$  is the number of terms.

According to Salton and Buckley's research, 1800 different combinations of document-query term weight assignments (i.e. matching functions) can be derived. Among these combinations, 287 were found to be distinct and six of them were recommended [SALT88]. The results of the experiments reported in [CAN90] indicate

that the matching function labeled as TW2 (tfc.nfx in [SALT88]) is the most effective one. Thus, TW2 is used as the search machine of HypIR.

### **3. SEARCH STRATEGIES**

#### **3.1 Full Search**

Full Search (FS) is implemented using inverted index search (IIS). In IIS, each distinct term in the system has a list of documents in which that term appears. Each document is represented by its document number and associated with the weight of the corresponding term. By traversing the list of those query terms, the similarity values of all database documents are calculated [SALT89]. The documents with the highest similarity values are then selected to answer the user's query. It is known that IIS is both effective and efficient [CAN92b, SALT89].

#### **3.2 Cluster-based Search**

In IR, there is a hypothesis known as the "clustering hypothesis," which states that "closely related documents tend to be relevant to the same query" [VANR79]. It is this hypothesis that supports the Cluster-based Search (CS) strategy. In CS, the documents are divided into several homogeneous groups (clusters). In a typical CS, the user queries are first compared with the cluster representatives (centroids). Then, after selecting best-matching clusters, detailed query-by-document comparison is performed within the selected clusters. (Note that this is a conceptual explanation. The actual implementation may be different.)

Although the selected clusters may not contain the best-matching documents, generally speaking, CS and clustering provide several advantages.

- (1) In a clustered document environment, the user may choose to browse the cluster of any retrieved document. This provides some expansion of recall ability, as not all documents in a cluster are relevant, but they are related in ways not always accessible through a query. Furthermore, during the process of cluster browsing, the user creates a better image of his information need and can submit a better query to the system.
- (2) In a multi-search IR system, CS constitutes a good alternative to FS.
- (3) The results of FS and CS can be combined to increase the system effectiveness. For instance, the combination of FS and CS may provide a precision improvement of up to 25 percent [CAN92a] (Precision is defined as the ratio of the number of retrieved relevant documents to the number of retrieved documents).
- (4) In a clustered environment, the documents of a cluster can be put into close physical proximity in secondary storage to decrease I/O time, and therefore, to increase system efficiency [SALT89].

### 3.3 Clustering Algorithm

In HypIR, the semantic relationships among documents is obtained using the Cover-Coefficient-based Clustering Methodology (C<sup>3</sup>M). In C<sup>3</sup>M, some of the documents are selected as the cluster initiators (seeds). Then the nonseed documents are assigned to one of the clusters initiated by the seed documents. C<sup>3</sup>M produces a single-level partitioning type clustering structure. The number of clusters,  $n_c$ , is determined using the Cover-Coefficient (CC) concept. According to CC, for an  $m$  document by  $n$  term  $D$  matrix, the value range of  $n_c$  and the average cluster size ( $d_c$ ) is as follows.

$$1 \leq n_c \leq \min(m, n), \quad \max(1, m/n) \leq d_c \leq m$$

In C<sup>3</sup>M, an  $m$  by  $n$   $D$  matrix is first mapped into an  $m$  by  $m$   $C$  matrix using the following formula.

$$c_{ij} = \alpha_i \cdot \sum_{k=1}^n (d_{ik} \cdot \beta_k \cdot d_{jk})$$

where  $1 \leq i, j \leq m$  and  $\alpha_i$  and  $\beta_k$  are the reciprocals of the  $i$ th row sum and  $k$ th column sum. This asymmetric  $C$  matrix shows the relationships among the documents of a database. The diagonal entries of the  $C$  matrix determine the number of clusters,  $n_c$ , and is used for the selection of cluster seeds. The relationships between a nonseed document ( $d_i$ ) and a seed document ( $d_j$ ) is determined by calculating  $c_{ij}$  entry of the  $C$  matrix. The whole clustering process requires the calculation of  $(m+(m-n_c)n_c)$  entries of the total  $m^2$  entries of the  $C$  matrix. This is a small fraction of  $m^2$ , since  $n_c$  is much less than  $m$ . A detailed discussion of C<sup>3</sup>M and its complexity analysis are available in [CAN90]. In a dynamic document environment the clusters of C<sup>3</sup>M can easily be updated without initiating a reclustering process [CAN92a]. The CS effectiveness of C<sup>3</sup>M is reported in [CAN90]. The mentioned study shows that the effectiveness of C<sup>3</sup>M is 15.1 to 63.5 (with an average of 47.5) percent better than four other clustering algorithms in CS.

### 3.4 Implementation of Cluster -based Search

Cluster-based Search (CS) is conventionally implemented in the following two ways.

CVDV: Match the query vectors with all the centroid vectors (CV) and the document vectors (DV) of the members of the best-matching clusters.

ICDV: Match the query vectors with the inverted indexes of centroids (IC) and the document vectors (DV) of the members of the best-matching clusters.

In addition to these conventional methods, the following method of implementation for CS has been introduced in [CAN92b].



ICIIS: Match the query vectors with the inverted indexes of centroids (IC) and the inverted indexes of all documents.

In ICIIS, the system first retrieves the best-matching clusters by matching the query vector with the inverted indexes of centroids. After obtaining the best-matching clusters, the documents of these clusters are selected using the results of IIS performed on the complete database. In other words, by using the ICIIS algorithm, the IR system can also provide the results of FS without extra effort. By definition the efficiency of ICIIS is independent of the number of clusters to be selected and the number of documents to be displayed to the user for browsing purposes. It is shown that ICIIS is much more efficient than other conventional CS implementation methods. Its efficiency is due to shortness of the query vectors, and it is especially suitable to very large databases [CAN92b].

#### 4. SYSTEM DATABASE AND FILES

##### 4.1 System Database

The document database of HypIR is the TODS/TOIS database covering the papers published in both *ACM Transactions on Database Systems* and *ACM Transactions on Information Systems*\*. In HypIR, each document of TODS/TOIS is represented by a document card consisting of the title, author(s), and the abstract of the corresponding article. For clustering purposes, the database is defined with a D matrix using an indexing software. The relevant statistics of the current TODS/TOIS database are listed in Table I.

Table I. Characteristics of the TODS/TOIS Database.

No. of documents (m)	:	524
No. of terms (n)	:	3668
No. of clusters ( $n_c$ )	:	65
No. of nonzero entries in the D matrix	:	28343
Average No. of terms per document	:	54.09

The TODS/TOIS database is currently adopted by a mainframe IR system, ANIRS, and is available on the Miami, IBM, environment [CAN92c]. The updates of TODS/TOIS and its clustering structure are conducted periodically [CAN92a].

##### 4.2 System Files

Several files are used in the implementation of HypIR. They are described in the following.

- (1) IID file :contains the inverted index representation of the D matrix and is needed for the selection of the best-matching documents using IIS.

---

\*Formerly ACM Transactions on Office Information Systems.

- (2) DV file :is a direct access file of document vectors of the D matrix and is used for the creation of IID file and the implementation of "Nearest Neighbors" browsing technique which returns the documents most similar to a located document.
- (3) IC file :contains the inverted index representation of the centroid vectors and is needed for the selection of the best-matching clusters.
- (4) CV file :is a direct access file of centroid vectors and is needed for the update of the IC file.

For better understanding of the major file structures, IID and IC, let us consider the example D matrix of Figure 2.A. The application of C<sup>3</sup>M to this D matrix produces the cluster C<sub>1</sub> = {d<sub>1</sub>, d<sub>2</sub>} and C<sub>2</sub>= {d<sub>3</sub>, d<sub>4</sub>, d<sub>5</sub>} [CAN90]. The centroids and templates of IID and IC for the example D matrix are depicted in Figure 2.B. In Figure 2.B, IID shows that t<sub>1</sub> appears in two documents: d<sub>1</sub> and d<sub>2</sub>; since the D matrix is binary, the term weights are ones. IC provides the same information for centroids. For example, the header information for t<sub>2</sub> indicates that it appears in two centroids (c<sub>1</sub> and c<sub>2</sub>). In cluster c<sub>1</sub> both members, d<sub>1</sub> and d<sub>2</sub>, contain t<sub>2</sub>, that is why the weight of t<sub>1</sub> in c<sub>1</sub> is two. Similarly, in c<sub>2</sub>, two members, d<sub>4</sub> and d<sub>5</sub>, contain t<sub>2</sub>.

$$D = \begin{matrix} & \begin{matrix} t_1 & t_2 & t_3 & t_4 & t_5 & t_6 \end{matrix} \\ \begin{matrix} \left[ \begin{matrix} 1 & 1 & 0 & 0 & 1 & 0 \\ 1 & 1 & 0 & 1 & 1 & 0 \\ 0 & 0 & 0 & 0 & 0 & 1 \\ 0 & 1 & 1 & 0 & 0 & 1 \\ 0 & 1 & 1 & 1 & 0 & 1 \end{matrix} \right] \end{matrix} & \begin{matrix} d_1 \\ d_2 \\ d_3 \\ d_4 \\ d_5 \end{matrix} \end{matrix}$$

Figure 2.A. Example D matrix.

**Inverted Index for Documents (IID)**

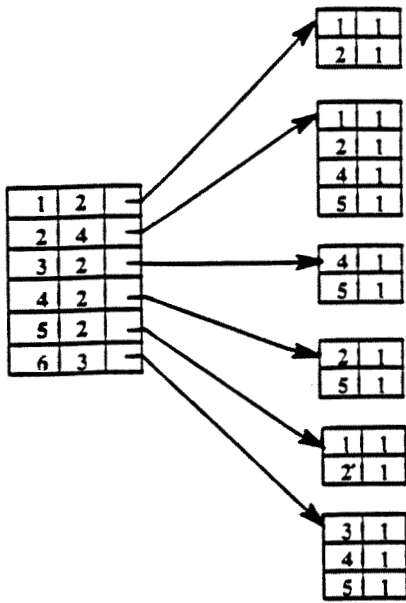

**Inverted Index for Centroids (IIC)**

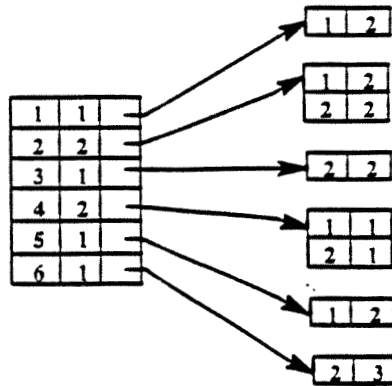

Templates of the IID and IC files:

IID : << Term No., No. of Documents Using This Term >> --> <Document No., Term Weight>+>+

IC : << Term No., No. of Centroids Using This Term >> --> <Centroid No., Term Weight>+>+

+ : indicates one or more occurrences of the enclosed information.

--> : indicates a pointer.

Figure 2.B. IID and IC file structures and templates.

## 5. USING HYPERTEXT FOR IR AND HypIR

### 5.1 Links and Nodes

It is commonly agreed that the major advantage of hypertext model is the non-sequential organization of the information. In a hypertext-based system, each piece of information on the screen can provide several links through which the user can browse the entire database and retrieve increasingly useful information. In general, the structures containing all the nodes and links in a hypertext system can be divided into two categories, hierarchical structures and network structures, as shown in Figure 3.

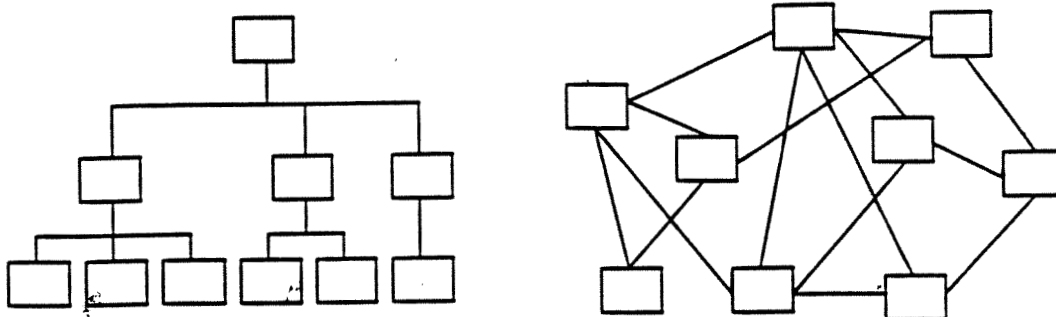

Figure 3. Hierarchical and network hypertext models.

In a hierarchical structure, the information is divided into several levels. Each lower level of the hierarchy provides more detailed information. Hence, the information can be searched and presented in a semantically meaningful way. For a bibliography database adopted in HypIR, the network structure is a better choice, since the hierarchical relationships are expensive to construct [WILL89]. In a network structured system, nodes are connected in a non-hierarchical manner. The links between the nodes may be embedded in the names of authors, the key terms, or an index list in the end of a node. Thus, the user's navigation is totally free in network environments.

## **5.2 Hypertext Browsing**

Browsing is a heuristic search through a well connected collection of documents in order to find information relevant to the user's needs [THOM89]. It provides two major advantages for IR.

- (1) By browsing the user's information need can become more and more clear. Hence, more appropriate queries can be created.
- (2) Since the related documents are linked together, a user can evaluate a large database in a rapid manner.

In a hypertext-based IR system, the user may browse

- (1) the documents written by the authors of the located document,
- (2) the references of the located document,
- (3) the documents in the same publication,
- (4) the documents that are very similar to the located document (i.e. the nearest neighbors),
- (5) the documents containing the same key terms.

In HypIR, all of these browsing methods are implemented and future modification or enhancement will be conducted according to users' feedback.

A major consideration when designing a hypertext-based IR system is to prevent users from getting lost during browsing. Currently, two major designs, "system map" and "history list", have been used in some hypertext systems [AGOS92, NIEL90]. The "system map" method, which is usually adopted in the hierarchical hypertext environment, is implemented by dividing the entire hierarchy of the system into several maps according to different subjects. Each map is then inserted into the links between the nodes. Thus, the user can navigate the entire collection according to the system maps. If the user is lost, he can still find the subjects which he was in. "History list" is usually a

special node in a hypertext system. It keeps a list of all the navigated nodes for the user. Whenever, the user is lost, he can still find a specific document by checking such a list.

Neither of these designs is not used in HypIR due to the following reasons.

- (1) In a system adopting system maps, all the documents must have a kind of semantic relationship which can be clearly expressed graphically.
- (2) System maps can not help the user find a specific document conveniently. In a large database, finding a navigated document may still consume a lot of time.
- (3) History list is a test for the user's memory, since it expects the user to memorize the titles of the documents without providing any hint.
- (4) History list does not provide any browsing ability.

In HypIR, a new approach is used. The detail of this design is provided in section 5.4.

### 5.3 HyperCard's Object-Oriented Philosophy

HypIR is implemented using the HyperCard graphic programming package, because of its hypertext nature, object-oriented philosophy, powerful scripting language and the ability to facilitate general purpose languages such as Pascal and C. The object-oriented philosophy of HyperCard visualizes the well known "object" in traditional object-oriented programming languages such as C++ or Smalltalk. In HyperCard, when a user needs a new object, it is not necessary to use a specific statement provided in the language. Instead, a graphic tool is provided to actually draw an object on the screen. The objects provided in HyperCard are stacks, backgrounds, cards, buttons, and fields. Each of these objects can be associated with a script which enables the object to respond to a HyperCard message. A system based on hierarchical inheritance and message passing can be constructed by combining these objects. The inheritance of HyperCard is based on the relationships between the objects as shown in Figure 4.

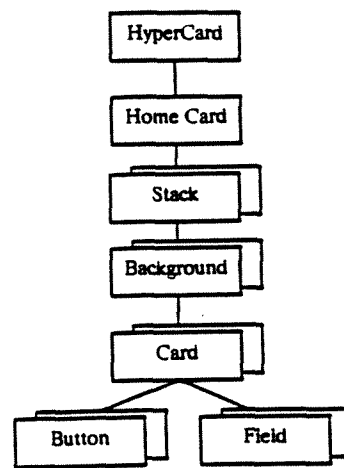

Figure 4. The hierarchy of objects in HyperCard.

The "stacks" and "cards" are actually HyperCard terminology to represent HyperCard files and screens, respectively. As in Figure 4, a stack may have several different backgrounds. A background can be shared by numbers of cards. Each card has several buttons and fields which distinguish from the other cards with the same background. Furthermore, from the bottom level to the top each object inherits all the HyperCard properties of the higher level object. For example, all the cards with the same background look similar to each other. All the backgrounds within a stack have the same size on the screen. Figure 4 also expresses the message passing strategy adopted in HyperCard. Whenever a message has been generated by an object, it will be either sent to a specific object if any exists, or it will be passed through the hierarchy until it is interrupted by an object on a higher level.

#### **5.4 HypIR System Design and Implementation**

The architecture of HypIR, is based on HyperCard's object-oriented philosophy. The whole system is accomplished by using three stacks, the HypIR stack, the help stack and the index stack as shown in Figure 5.

The HypIR stack is the main body of the entire system which contains a main menu card, a query processing card, and several title list cards, author list cards and document cards. After accessing the system, the user is first led to the main menu card (Figure 6). On this card, the user can make a decision among several searching strategies and start the navigation in the system. The user may click on

- (1) The "Automatic Search" icon to access query processing card,
- (2) The "Doc List" icon to browse the titles of the entire collection of documents (In this case, we assume that the user does not have any particular destination to start the searching.),
- (3) The "Authors" icon and then type in the last name of a particular author in a pop-up dialog box. Consequently, a list of the author's papers are provided by the system,
- (4) One of the "books" and obtain a list of documents in a certain volume of the collection.

All the previous choices, except (1), provide the user a starting point to begin with his navigation. For example, after obtaining a list of documents (Figure 7), the user then browses through the document titles. Whenever an interesting document title is found, the user can click on the title and access the content of this document (Figure 8).

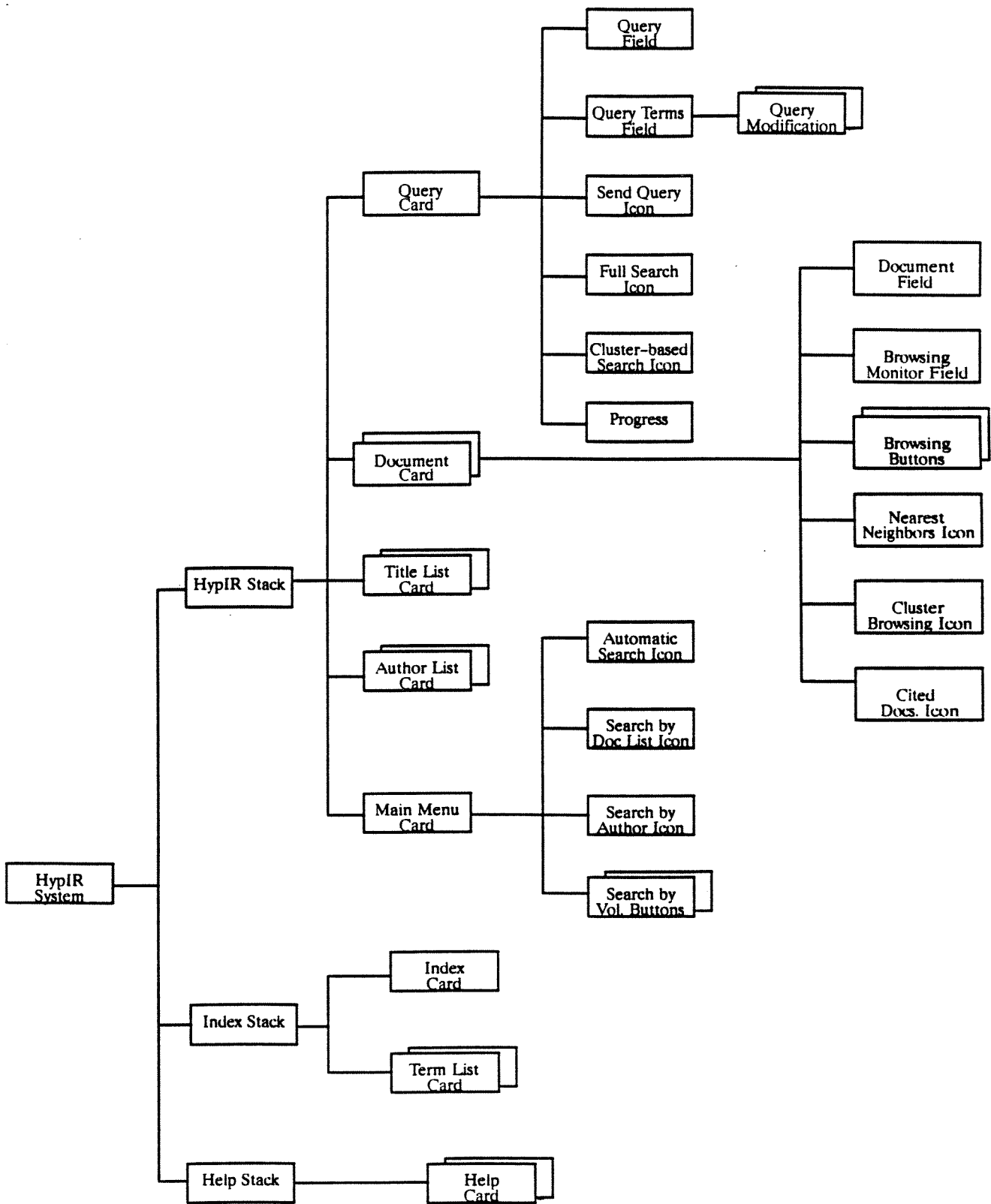

Figure 5. HypIR system design.

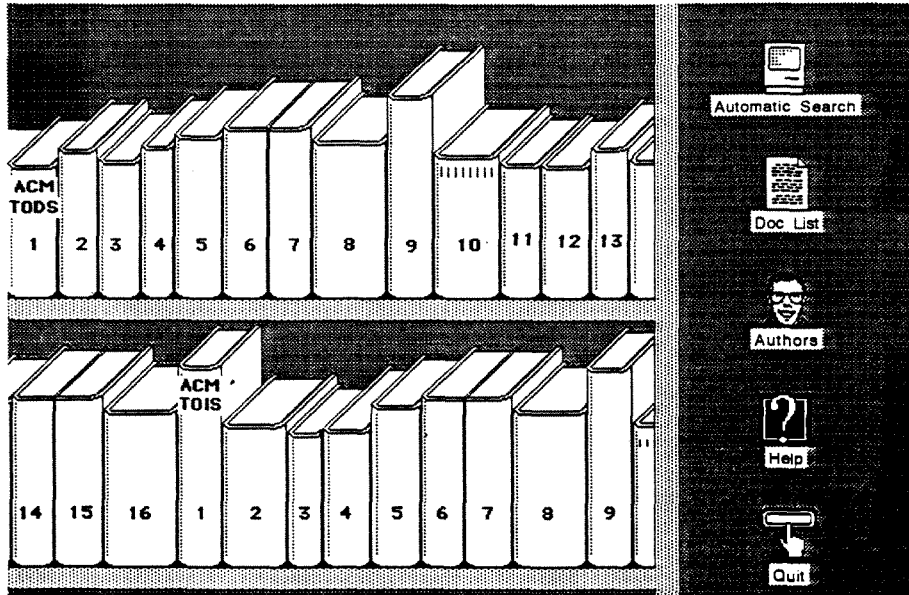

Figure 6. Main menu in HypIR.

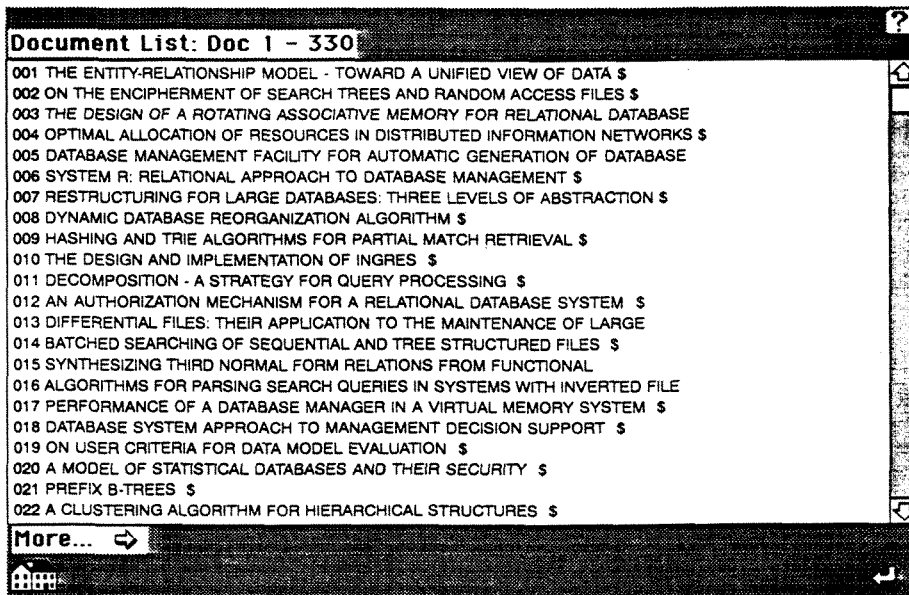

Figure 7. An example of document list in HypIR.



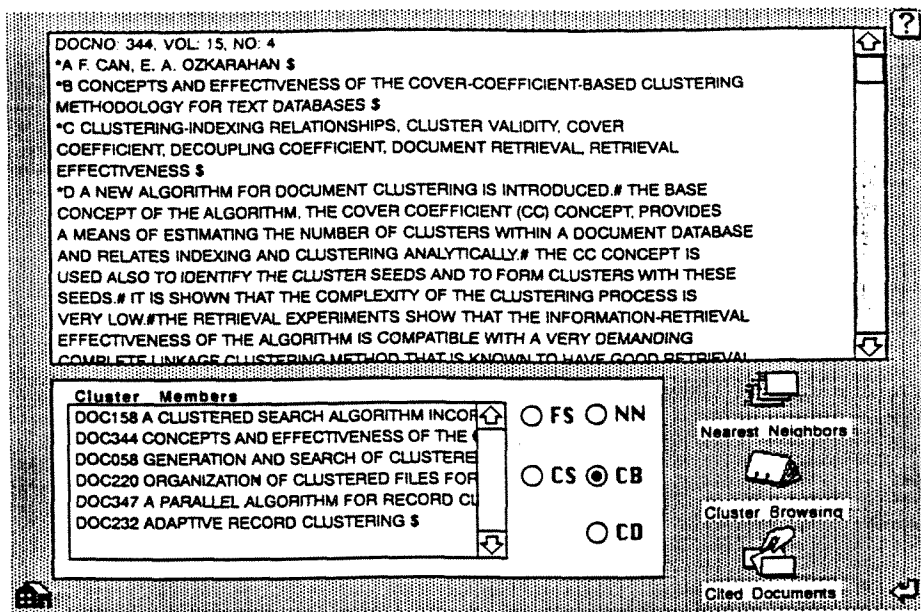

Figure 8. Document card in HypIR.

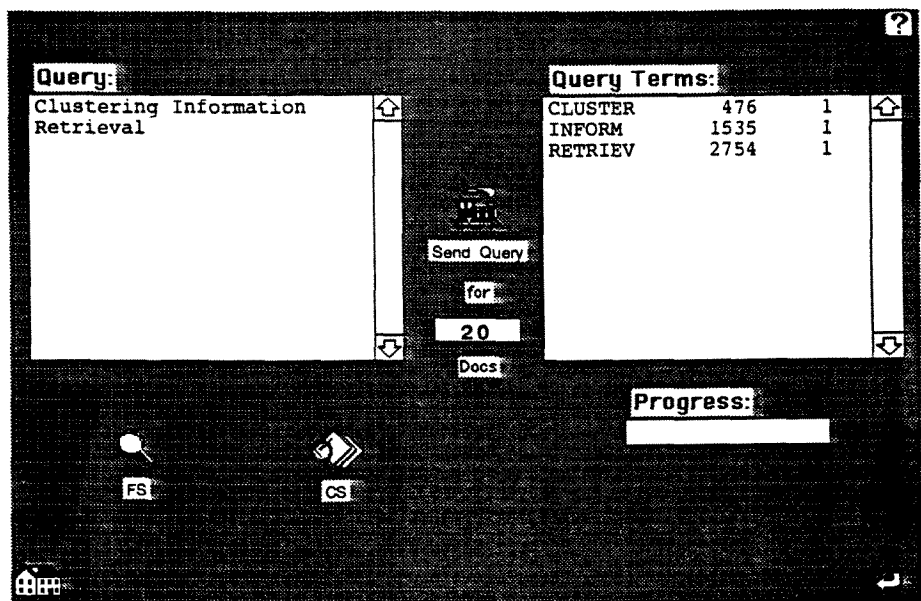

Figure 9. Query processing card in HypIR.

"Automatic Search" icon displays the query processing card (Figure 9). On this card, the user can first type in his query in natural language, click on the "Send Query" icon and obtain the corresponding query vector from the "Query Terms" field. If the user wants to modify the query vector, HypIR provides a simple method. To delete a query term, the user can click on the term itself. By doing so, the system will pop-up a dialog box (Figure 10) to request an action from the user. After the user clicks on the "Delete

Term" button, the specified term will be erased from the query vector. A similar approach is also provided for the modification of a term weight. The only difference is that the user needs to type in the term weight in another dialog box (Figure 11). To add a new term, the user can click on any spot on the "Query Terms" field. After responding to the same dialog box shown in Figure 10, the "Index" stack will appear in a new window (Figure 12). By clicking on the letters in the window and using the same approach as checking a dictionary, the user can easily locate desired term and add it to the query vector.

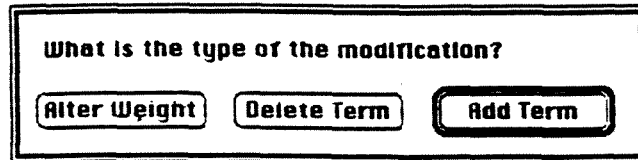

Figure 10. Query modification dialog box.

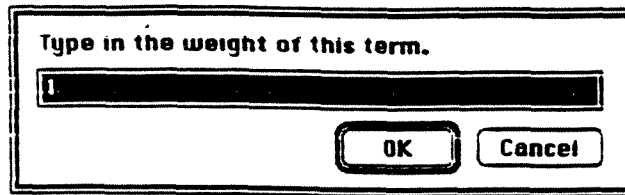

Figure 11. Term weight dialog box.

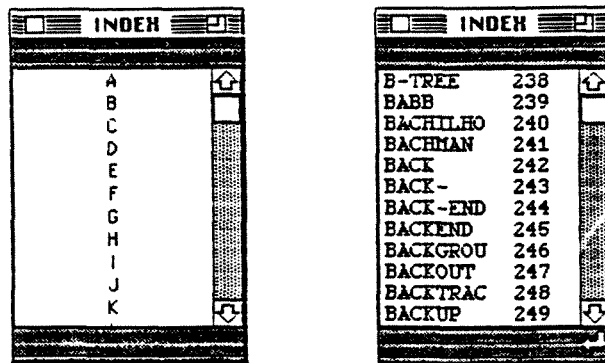

Figure 12. Index windows.

The "FS" and "CS" icons represent the searching techniques, Full Search and Cluster-based Search, respectively. As defined before, FS and CS provide a list of the best-matching documents of the query vector in the entire database and the selected clusters, respectively. Again, the user accesses the content of the documents by clicking on their titles.

The document card as shown in Figure 8 contains several icons to support different types of browsing. The "Nearest Neighbors" icon provides the function that sends the

entire document as a query and returns the nearest neighbors of it as the result. The "Cluster Browsing" icon provides a way that the user reveals all the members of the cluster in which the located document resides. The "Cited Documents" icon provides all the titles of the documents cited by the located document. Furthermore, browsing by key terms is also available in HypIR. The "Document" field contains a script that allows the user to navigate the entire database by clicking on any word which appears in the located document.

The field appearing on the bottom left corner of the document card is responsible for displaying the results of all the previous mentioned functions. It keeps track of the results of FS (Full Search), CS (Cluster-based Search), NN (Nearest Neighbors), CB (Cluster Browsing) and CD (Cited Documents). For instance, the user may first locate a document using the FS function, then traverse the database by using CB function or links of key terms. After all of these, the user may still want to see other documents found by FS. To do so only requires a click on one of the five radio buttons. In this case, "FS" button is the appropriate choice, of course. By doing so, the user can go back to the original path, once again. Due to the functionality of this field, it is named as *browsing monitor*.

The major reason that we adopted browsing monitor is to prevent the user from getting lost in HypIR. This design actually contains both of the advantages of system maps and history lists. It not only tracks all the navigated documents, but also groups the documents according to the retrieval function. Since the switching among different groups is so handy, we believe that browsing monitor provides a more convenient and practical aid to the user than system maps and history lists.

## 6. CONCLUSION

Information retrieval (IR), also known as text or document retrieval, is the process of locating and retrieving documents that are relevant to the user queries. In hypertext environments, document databases are organized as a network of nodes which are interlinked by various types of links. Through the links, the documents are navigated or browsed in a non-sequential manner which is totally controlled by the user. In a hypertext-based retrieval system, the browsing of documents should be triggered by so-called "optimal" starting nodes.

In this paper, we introduced HypIR, a hypertext-based IR system which is implemented in the HyperCard environment of Macintosh. In HypIR, the semantic relationships among documents are obtained using the C<sup>3</sup>M clustering algorithm which is known to have good IR performance. For information retrieval, the users are provided with various search and browsing tools. These include full search (FS), cluster-based

search (CS), nearest neighbors (NN) search, cluster browsing (CB) and others. In HypIR, the user enters natural language queries and can easily modify them. The paper introduces the underlying concepts, implementation details and the object-oriented nature of the HypIR system.

To prevent the user from being lost in the IR hyperspace, a new approach, browsing monitor, is introduced. Browsing monitor provides the advantages of system maps and history lists without their difficulties of usage.

In the future, the modification and enhancement of HypIR can be conducted by utilizing users' feedback. Two other future research possibilities are the design and implementation of an on-line thesaurus for better query formulation, and the development of performance measurement methods that would be appropriate for hypertext-based IR systems.

## REFERENCES

[AGOS92] Agosti, M., Gradenigo, G., Marchetti, P. G. A hypertext environment for interacting with textual database. *Information Processing & Management*. 28, 3 (1992), 371-387.

[APPL88] Apple Computer, Inc. *Inside Macintosh I-VI*. Addison Wesley, Reading, MA 1988.

[BELK87] Belkin, N. J., Croft, W. B. Retrieval techniques. In *Annual Review of Information Science and Technology*, ARIST. Vol. 22, M. E. Williams, Ed. Elsevier Science, Amsterdam, The Netherlands, 1987, 109-145.

[BOND88] Bond, G. *XCMD's for HyperCard*, MIS Press, OR, 1988.

[CAN90] Can, F., Ozkarahan, E. A. Concepts and effectiveness of the cover-coefficient-based clustering methodology for text databases. *ACM Transactions on Database Systems*. 15, 4 (Dec. 1990), 483-517.

[CAN92a] Can, F. Incremental clustering for dynamic information processing *ACM Transactions on Information Systems*, to appear.

[CAN92b] Can, F. On the efficiency of best-match cluster searches. (Tentatively accepted by *Information Processing and Management*.)

[CAN92c] Can, F., McCarthy, K. J. Implementation of an information retrieval system (ANIRS) with ranking and browsing capabilities. Working paper 92-001, Dept. of System Analysis, Miami Univ., Oxford. Ohio, April 1992.

[CROF87] Croft, W. B., Thompson, R. H. I<sup>3</sup>R: A new approach to the design of document retrieval systems. *Journal of the American Society for Information Science*. 38, 6 (Nov. 1987), 389-404.

- [CROU89] Crouch, D. B., Crouch, C. J., Andreas, G. The use of cluster hierarchies in hypertext information retrieval. *Hypertext '89 Proceedings*. (November 1989), 225-237.
- [FALO85] Faloutsos, C. Access methods for text. *ACM Computing Surveys*. 17, 1 (Mar. 1985), 49-74.
- [FRIS88] Frisse, M. E. Searching for information in hypertext medical handbook. *Communications of the ACM*. 31, 7 (July 1988), 880-886.
- [GAUC92] Gauch, S. Intelligent information retrieval: An introduction. *Journal of the American Society for Information Science*. 43, 2 (March 1992), 175-182.
- [HARM91] Harman, D. How effective is suffixing? *Journal of the American Society for Information Science*. 42, 1 (Jan. 1991), 7-15.
- [HARM92] Harman, D. User-friendly system instead of user-friendly front-ends. *Journal of the American Society for Information Science*. 43, 2 (March 1992), 164-174.
- [LIBC91] Library of Congress. *American Memory Instruction Manual*. Washington D.C., October 1991.
- [NIEL90] Nielsen, J. *Hypertext and Hypermedia*. Academic Press, San Diego, CA, 1990.
- [PORT80] Porter, M. F. An algorithm for suffix stripping. *Program*. 14, 3 (July 1980), 130-137.
- [SALT88] Salton, G., Buckley, C. Term-weight approaches in automatic text retrieval. *Information Processing and Management*. 24, 5 (May 1988), 513-523.
- [SALT89] Salton, G. *Automatic Text Processing*. Addison Wesley, Reading, MA, 1989.
- [SHAF91] Shafer, D. *The Complete Book of Hypertalk 2*. Addison Wesley, Reading, MA, 1991.
- [SYMA90] Symatec Corporation, *THINK Pascal User Manual*, U.S.A. 1990.
- [THOM89] Thompson, R. H., Croft, W. B. Support for browsing in an intelligent text retrieval system. *Int. J. of Man-Machine Studies*. 30, (1989) 639-668.
- [VANR79] Van Rijsbergen, C. J. *Information Retrieval*, 2nd ed. Butterworths, London, 1979.
- [WILL89] Willett, P. Recent trends in hierarchical document clustering: A critical review. *Information Processing and Management*. 24, 5 (1989), 577-597.

## APPENDIX I: IMPLEMENTATION DETAILS OF HypIR

### A. Programming in THINK Pascal

This section provides the necessary information to create Think Pascal projects and source files. In THINK Pascal, to create an executable program, the user needs to create a project. The project file should include the source files and two THINK Pascal library files, `runtime.lib` and `interface.lib`, which support the Think Pascal language (i.e. support the standard I/O and other Pascal functions). The project is only compiled at the first time that the programmer executes the THINK Pascal compiler. Later, the THINK Pascal compiler will only compile the updated parts of the program (i.e. the source files). By doing so, a lot of compilation time can be saved.

To create a project, the programmer should

- (1) Use the Finder's *New Folder* command to create a new folder. This folder will contain the THINK Pascal project and all of the source files.
- (2) Double-click on the THINK Pascal icon. Then, a dialog box will pop-up to ask a working project. Since we are creating a new project, click on the *New* button. (THINK Pascal user manual p 24).
- (3) Name the project as the following format in another dialog box (THINK Pascal user manual p 25) [SYMA90].  

`filename.π`
- (4) Then, Think Pascal will create a new project document on the disk and display a project window which contains the `Runtime.lib` and `Interface.lib` files. At this step, a new project has been created successfully.

To create a new source file, the programmer can

- (1) Choose the *New* from the File menu. Then, an empty window will appear on the screen.
- (2) Type in the source code.

After creating the project and source files, the source files must be added to the project. To add a source file to the project, simply use the *Add* command in the project menu. The project window should now contain three files, `Runtime.lib`, `interface.lib` and the source file.

To execute the program, simply choose *Go* from the Run menu.

## B. Creating a HyperCard XCMD Resource

The creation of a HyperCard XCMD is similar to the creation of a Think Pascal program. However, after successfully accomplishing step 1 to step 4 in the previous section, the programmer needs to

- (1) Select *Set Project Type...* from the Project menu and click the Code Resource icon on the left side of the dialog box.
- (2) Fill in the dialog according to the specification in Fig 13.

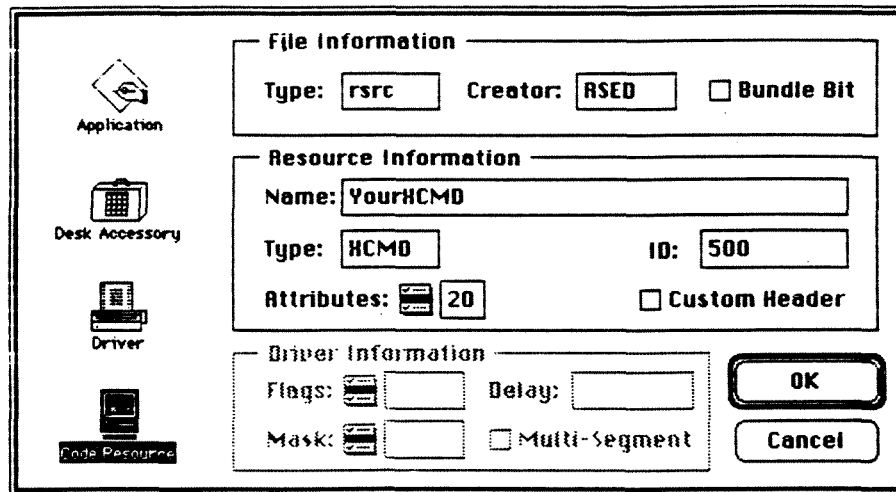

Figure 13. An example of Set Project Type... dialog box.

- (3) Click *OK* to save the changes.
- (4) Add some files to the project that are necessary for creating stand-alone code resources that work with HyperCard. First of all, the Runtime.lib file must be replaced by its code resource counterpart, DRVRRuntim.lib. To do this, click on the file Runtime.lib in the project window. Remove it from the project by selecting *Remove* from the Project menu. The file Runtime.lib should disappear from the project window.
- (5) Select *Add File...* from the Project menu and add the files DRVRRuntime.lib, HyperXlib.lib, and HyperXCmd.p to the project. All three files can be found within the Think Pascal folder. DRVRRuntim.lib and HyperXLib.lib are in Libraries subfolder. HyperXCmd.p is in the Interfaces folder.

(6) Type in your source code according to the following template.

```
unit DummyUnit;
interface
  uses
    HyperXCmd;
  procedure Main (paramPtr: XCmdPtr);
implementation
  procedure Main (paramPtr: XCmdPtr);
  begin
    { Type in the source code in this block }
  end;
end.
```

(7) Save the file and add it to the project.

(8) Rearrange the order of the files within the Project window as the following order by using the hand cursor that appears when the mouse is inside the project window. Drag the files up or down until the order matches the following.

```
DRVRRuntime.lib
Interface.lib
HyperXLib.lib
HyperXCmd.p
YourXCMD.p                { This is the XCMD file. }
```

(9) Build the XCMD resource by selecting *Build Code Resource...* from the Project menu. Save the XCMD.

### C. Add the XCMD to HyperCard stack

- (1) Execute the ResEdit application by double-clicking the XCMD file.
- (2) Choose *Copy* from Edit menu.
- (3) Click on HyperCard's icon. A new window which contains all the resource folders of HyperCard will appear on the screen.
- (4) Click on XCMD folder. Now, the XCMD folder should be highlighted.
- (5) Choose *Paste* from the Edit menu.
- (6) Select *quit* from the File menu.
- (7) Click on *Yes* in the new pop-up dialog box.

Now, the new XCMD is usable in the HyperCard. However, the programmer can also build the XCMD in a normal stack, although this XCMD can be recognized only in the specified stack. To do so, replace step 3 by step 3.a.

(3.a) Click on the icon which represents the stack in which the XCMD should be built.



## D. Use XCMD in HyperTalk

The new XCMD can be used as a standard HyperTalk command. To use it, just use the name which was typed in the *Set Project Type...* dialog box as the actual command of the XCMD.

## E. The HyperCard glue routines

There are 29 glue routines in *HyperXcmd.p* which are a collection of procedures and functions that provide access to some of the routines and data inside HyperCard. The glue routines are the only method by which the user can set and get the contents of a HyperCard field, set and get the contents of a HyperTalk variable, evaluate a HyperTalk expression, or send a HyperCard message. (Note that *DRVVRtime.lib* has been replaced by *Runtime.lib*. This makes all of the THINK Pascal standard I/O functions unavailable.)

In this section, we would like to provide a brief description of the routines which are frequently used in HypIR system programs.

### (1) *SendCardMessage*

*SendCardMessage* sends a card message (HyperCard command) to the current card. From there, the message traverses the inheritance path in the normal way. Any command can be sent as a message (including the user defined command).

### Parameters

Procedure *SendCardMessage* (paramPtr: XCmdPtr; msg: Str255);

It takes a string of type *Str255*, representing the card message as one of its major arguments. *XCmdPtr* is a pointer of a record (*XCmdBlock*). It contains declarations for the actual communication between HyperCard and the XCMD. It is not needed to understand this record completely. To write a XCMD, the programmer can just use *paramPtr* to be the first parameter in any glue routine. Thus, in the rest of this section, we will ignore the description of this parameter. To get better understanding of *XCmdBlock*, the programmer can reference *XCMD's for HyperCard* by G. Bond [BOND88].

### Examples

```
SendCardMessage(paramPtr, 'put field 1 into field 2');
```

```
SendCardMessage(paramPtr, 'go to card "home"');
```

## (2) PasToZero

This is one of the most frequently used routine in HypIR, since HyperCard utilizes zero-terminated string which is not compatible with the string type in THINK Pascal language. Thus, every variable or data that the programmer wants to send to HyperCard must be converted by this routine first. PasToZero converts the contents of a Pascal string to a zero-terminated string and returns a handle to the converted string. ( A handle is a pointer which points to another pointer.) The programmer must dispose of the handle before exiting the XCMD (use the DisposHandle ROM routine; for additional information see Inside Macintosh [APPL88].)

### Parameters

Function PasToZero(paramPtr: XCmdPtr; str: 255):Handle;

It takes the Pascal string to be the major parameter.

### Examples

```
paramPtr^.returnValue := PasToZero(paramPtr, 'store my error message in field 1');
```

paramPtr^.returnValue is a field in XCmdBlock record and can be treated as a reserved variable. The string assigned to this variable can be retrieved in HyperTalk by a HyperTalk reserved word "The result".

## (3) ZeroToPas

For the reason mentioned in (2) PasToZero, this routine is used whenever the XCMD gets a string from HyperCard.

### Parameters

Procedure ZeroToPas (paramPtr: XCmdPtr, var zeroStr:Ptr; var pasStr: str255);

It contains two major parameters. The first is a pointer to a zero-terminated string, and the second is a string variable of type str255 into which the converted string will be placed.

### Examples

see (4) EvalExpr

## (4) EvalExpr

EvalExpr evaluates a HyperTalk expression.

parameters

```
Function EvalExpr (paramPtr: XCmdPtr; expr: Str255): Handle;
```

The EvalExpr function takes a Pascal string of type Str255, representing the expression to be evaluated in HyperCard, and returns a handle.

Examples

```
ZeroToPas(paramPtr, EvalExpr (paramPtr, 'the first word of field 1 of card 1')^,str);  
ZeroToPas(paramPtr, EvalExpr (paramPtr, 'the number of words in field 1')^, str);
```

(5) StrToLong

Since the only data type in HyperTalk is zero-terminated string, data coming from HyperCard may need this routine to convert itself to long integer.

Parameters

```
Function StrToLong (paramPtr: XCmdPtr; Str: Str31): Longint;
```

It takes a parameter of type Str31 that contains the value to be converted. It returns an unsigned long integer.

Examples

```
myLongInt := StrToLong(paramPtr, mystring);  
myLongInt := StrToLong(paramPtr, '3333');
```

(6) LongToStr

Any long integer that is needed to send back to HyperCard must be converted by using this routine.

Parameters

```
Function LongToStr (paramPtr: XCmdPtr; posNum: LongInt): str31;
```

It takes a longint representing the number to be converted as one of its arguments and returns a string of type Str31.

Examples

```
myString := LongToStr(paramPtr, 2345);  
myString := LongtoStr(paramPtr, myLongInt);
```

### (7) GetGlobal

GetGlobal returns a handle to the content of a HyperTalk global variable. The global variable must have been declared in a HyperTalk handler prior to calling XCMD and must be passed by name.

#### Parameters

Function GetGlobal (paramPtr: XCmdPtr; globalName: Str255): Handle;

GetGlobal functions takes a string of type Str255 (representing the name of the global variable) as its argument and returns a handle that points to the zero-terminated contents of that variable.

#### Example

{ This example assumes a HyperTalk global variable was first declared with the name }  
{MyList}

Var

    myHandle:    handle;

    inList: Str255;

begin

    .....

    .....

        myHandle := getGlobal (paramPtr, 'MyList');

        ZeroToPas(paramPtr, myHandle^, inList);

    .....

end;

### (8) SetGlobal

SetGlobal sets the contents of a specified HyperTalk global variable to the contents of a zero-terminated string.

#### Parameters

Procedure SetGlobal (paramPtr: XCmdPtr; globName:Str255; globValue: Handle);

It contains two major parameters. The first is a string of type Str255 that contains the name of the global to be set, and the second is a handle to a zero-terminated string.

## Examples

{This example assumes a HyperTalk global variable was first declared with the name}  
{fieldTotal}

Var

myHandle: handle;

begin

.....

.....

SetGlobal (paramPtr, 'fieldTotal', myHandle);

DisposHandle (myHandle); {must dispose of the Handle after setting the global}

### (9) GetFieldByName

GetFieldByName returns a handle to a zero-terminated string that points to the contents of a card or background field. The field is specified by its name.

#### Parameters

Function GetFieldByName (paramPtr: XCmdPtr; cardFieldFlag: Boolean; fieldName: Str255): Handle;

It contains two major parameters. The first parameter is of type Boolean and determines what kind of field - card or background - will be accessed; use TRUE for a card field or FALSE for a background field. The second parameter is of type Str255 and contains the name of the field whose contents is needed by the XCMD.

## Examples

{This example assumes a HyperTalk card field was first declared with the name}  
{TestField.}

Var

myHandle: handle;

myCardField: Boolean;

fieldName: Str255;

pasStr: Str255;

```

begin
.....
.....
    fieldName := 'TestField';
    myCardField:=StrToBoolean(paramPtr,'TRUE'); {make it a card field}
    {get the contents of card field 'TestField'}
    myHandle := GetFieldByName(paramPtr, myCardField, fieldName);
    ZeroToPas(paramPtr, myHandle^, pasStr);
    DisposHandle(myHandle);
.....

```

#### (10) SetFieldByName

SetFieldByName sets the content of a card or background field to a zero-terminated string. The field is specified by its name.

#### Parameters

Procedure SetFieldByName (paramPtr: XCmdPtr; cardfieldFlag: Boolean; fieldName: str255; fieldVal: Handle);

It contains three major parameters. The first parameter contains a Boolean value that determines what kind of field - card or background - will be set; use TRUE for a card field or FALSE for a background field. The second parameter is of type Str255 and contains the name of the field to be set. The third parameter contains a handle that points to a zero-terminated string.

#### Examples

{This example assume a card field has been created and named 'TestField'}

```

var
    myHandle: Handle;
    myCardField: Boolean;
    fieldName: Str255;

```

```

begin
.....
.....

```

```

    fieldName := 'TestField';
    myCardField := StrToBool (paramPtr, 'TRUE');
    SetFieldByName := (paramPtr, myCardField, fieldName, myHandle);
    DisposHandle(myHandle); {must dispose of the handle before exiting}
end;
```

## **F. The file manager routines of Macintosh Toolbox**

File manager is the part of the Macintosh operating system that controls the exchange of information between a Macintosh application and files. The file manager allows the programmer to create and access any number of files containing whatever information.

Compared to the standard I/O routines in Pascal, file manager is on a lower level. Thus, to use file manager, there is no so-called direct access file or sequential file. The user can always access any position of a file.

(1) Function `GetVInfo` (`drvNum: integer; volName: StringPtr; var vRefNum: integer; var freebytes: integer`) : `OSErr`;

It returns the name, reference number, and available space (in bytes), in `volName`, `vRefNum`, and `freeBytes`, for the volume in the drive specified by `drvNum`. `OSErr` is used for error detection. If it is equal to 0, it means no error has occurred during the execution of the function. Detailed information of `OSErr` is available in *Inside Macintosh III* [APPL88].

(2) Function `FSOpen` (`filename: Str255; vRefNum: integer; var refNum: integer`) : `OSErr`;

It creates an access path to file having the name `fileName` on the volume specified by `vRefNum`. A path reference number is returned in `refNum`. The access path's read/write permission is set to whatever the file's open permission allows.

(3) Function `FSRead` (`refNum: integer; var count: longint; buffptr: Ptr`) : `OSErr`;

`FSRead` attempts to read the number of bytes specified by the `count` parameter from the open file whose access path is specified by `refNum`, and transfers them to the data buffer pointed to by `buffPtr`. The read operation begins at the current mark, so the user might want to precede this with a call to `SetPos`. If the user try to read past the end-of-file, `FSRead` moves the mark to the end-of-file and returns an error message by setting `OSErr` to nonzero. After the read is completed, the number of bytes actually read is returned in the `count` parameter.

(4) Function SetFPos (refNum: integer; posMode: integer; posOff: longint): OSErr;

It sets the mark of the open file whose access path is specified by refNum to the position specified by posMode and posOff. Posmode indicates how to position the mark; it must contain one of the following values:

```
const    fsAtMark      = 0;  {at current mark}
         fsFromStart   = 1;  {set mark relative to beginning of file}
         fsFromLEOF    = 2;  {set mark relative to End-of-File}
         fsFromMark    = 3;  {set mark relative to current mark}
```

(5) Function FSClose ( refNum: integer): OSErr;

FSClose removes the access path specified by refNum, writes the content of the volume buffer to the volume, and updates the file's entry in the file directory.

As mentioned before, the programmer actually does not have standard I/O Pascal functions when writing a XCMD. In general, when it is necessary to read/write data from/to the screen, glue routines are used to replace standard I/O function (i.e. read, readln, write, writeln, etc.). When it is needed to read/write data from/to files, Macintosh file manager routines are used to replace the standard I/O Pascal functions. For further description of glue routines and file manager routines, programmers should reference to XCMD's for HyperCard and Inside Macintosh IV, respectively [APPL88, BOND88].

## **APPENDIX II. SUMMARY OF PROGRAMS AND FILES USED IN HypIR**

### **XCMDs**

- (1) FSDOCS.P : the source code of the full search XCMD.
- (2) CBSDOCS2.p : the source code of the cluster-based search XCMD.
- (3) SEEDDOCS.P : the source code of the nearest neighbors XCMD.
- (4) BROWSECL.P : the source code of the cluster browsing XCMD.
- (5) CITEDDOC.P : the source code of the cited documents XCMD.
- (6) PREPAREQ.P : the source code of the XCMD of the stemming function (i.e. send query function).

### **Major Files in HypIR**

- (1) IID file consists of IIS.bin and IISHead.bin files which are generated by FILEMAKE.P Pascal program using the input files.



(2) IC file consists of IC.bin and ICHead.bin files which are generated by CBSFILEM.P Pascal program using the input files.

(3) DV file consists of DV.bin and DVHead.bin files which are generated by MAKEDVFL.P Pascal program using the input files.

(4) CM file consists of CMEMBERHEAD.bin and CMEMBER.bin which are generated by CBSCMEM.P Pascal program using the input files.

(5) The file of Cited Documents consists of CITEDDOCS.bin and CITEDDOCSHEAD.bin which are generated by CITEMAKE.P PASCAL program using the input files.

Furthermore, the following data files are used for calculating the similarity values between "query and documents" and "query and centroids".

(1) IISNC.bin and IISTermDistn.bin contain the normalization component and collection frequency component , respectively, for each document. They are generated by FILEMAKE.p Pascal program.

(2) ICNC.bin and ICTermDistn.bin contain the normalization component and collection frequency component , respectively, for each cluster. They are generated by CBSFILEM.p Pascal program.

### APPENDIX III: THE MAINTENANCE OF HypIR

The maintenance of HypIR is supported by a card called "update" in the "HypIR" stack (Figure 14). On this card, the "Update Lists" button provides a function which will add the authors and titles of the new documents to the author list and title list. The "Export Text" button contains a script which can write the entire TODS/TOIS database to a text file.

**UPDATE CARD**

UPDATE STEPS:

1. CREATE NEW DOCUMENTS ON SEPARATE CARDS.
2. ENTER NO. OF CURRENT DOCUMENTS AND NO. OF DOCUMENTS AFTER UPDATE IN THE FOLLOWING FIELDS.
3. CLICK "Update Lists".
4. CLICK "Export Text" TO CREATE A TEXT FILE CONTAINING ALL DOCUMENTS.

ENTER NO. OF CURRENT DOCUMENTS:                    0

ENTER NO. OF DOCUMENTS AFTER UPDATE:            524

Figure 14. Update card in HypIR.